



INTERCOM SYSTEMS

A GLOBAL SOLUTION FOR AUDIO
AND COMMUNICATIONS





Until Today, existing technology forced customers to work with separate systems to manage audio and communications. They were normally completely separate systems that didn't allow for interoperability and to optimize through resource sharing.

For the last few years, at AEO our aim has been to provide full integration.

Matrix-based systems

This will allow the user to share resources, simplify the operation and to control production based upon very stable, redundant systems, with the best available audio quality and possibility to extensively process the audio signals. State-of-the-art technology that provides connectivity to AoIP networks with centralized control. In a nutshell, a leap forward towards 360° management of all your contents in a simple way, making the achievement of the best possible final results and easy task.

In order to achieve this goal, we cannot forget about audio quality at any moment. That's why our matrix systems process the audio signal with 48 KHz sampling rate and 24 bits resolution, providing a broadcast-quality flow between all devices. One of the most important reasons that allows us to keep this quality level is the use of AoIP Dante™/ AES67 standard for the audio transport between equipment.

We are always open to inter-operate with third-party equipment using other formats, such as RAVENNA, MADI, SDI-embedded audio SMPTE ST 2110-30, SMPTE ST 2110-31 and any other that may become standard or popular.

Matrix-less systems

Those systems incorporate solutions for our users' new requirements: simple configuration of de-centralized systems to enable and simplify remote production; Bluetooth and USB connectivity, simplifying operation with a wide variety of headset combinations, enabling audio-tethering with PCs, among others.

AEO's experience in offering audio solutions for large international events, acquired throughout our long history and in combination with our close contact to customers having a great variety of operational needs, allows us to have a clear idea of what is required in terms of quality, reliability and operational workflows for any production.



Index

SECTION 1. INTEGRATED SOLUTION - AUDIO AND COMMUNICATIONS	4
Conexia. Modular Intercom Matrix	4
Crossnet. Compact Intercom Matrix	9
TP 8000. Wired User Panels	11
Olympia 3. User Panel and Commentary Unit	13
Xpeak. Wired User Panels	14
Xplorer. Wireless User Panel	16
Xvirtual. Virtual User Panel	17
An example of a matrix intercom system at a theatre	18
Complementary Equipment: audiocodecs, phone systems & IP Dante/AES67 interfaces	19
Crossmapper. Set Up Software for Matrix Systems	20
Live Crossmapper. Real-time operational software for Matrix Systems	21
General diagram of the AEQ matrix intercom system	22
SECTION 2. MATRIX-LESS, DE-CENTRALIZED INTERCOM SYSTEM	24
Xpeak. Product Concept	24
Xpeak R and Xpeak D. User Panels	25
Xpeak BP Beltpack and Xpeak Virtual software application	26
Xplorer Wireless Beltpack and Xpeak IF audio format converter	27
Xpeak. General Features	28
Xpeak. Operating modes and Technical Features	29
X-Peak software for Xpeak control and configuration	30

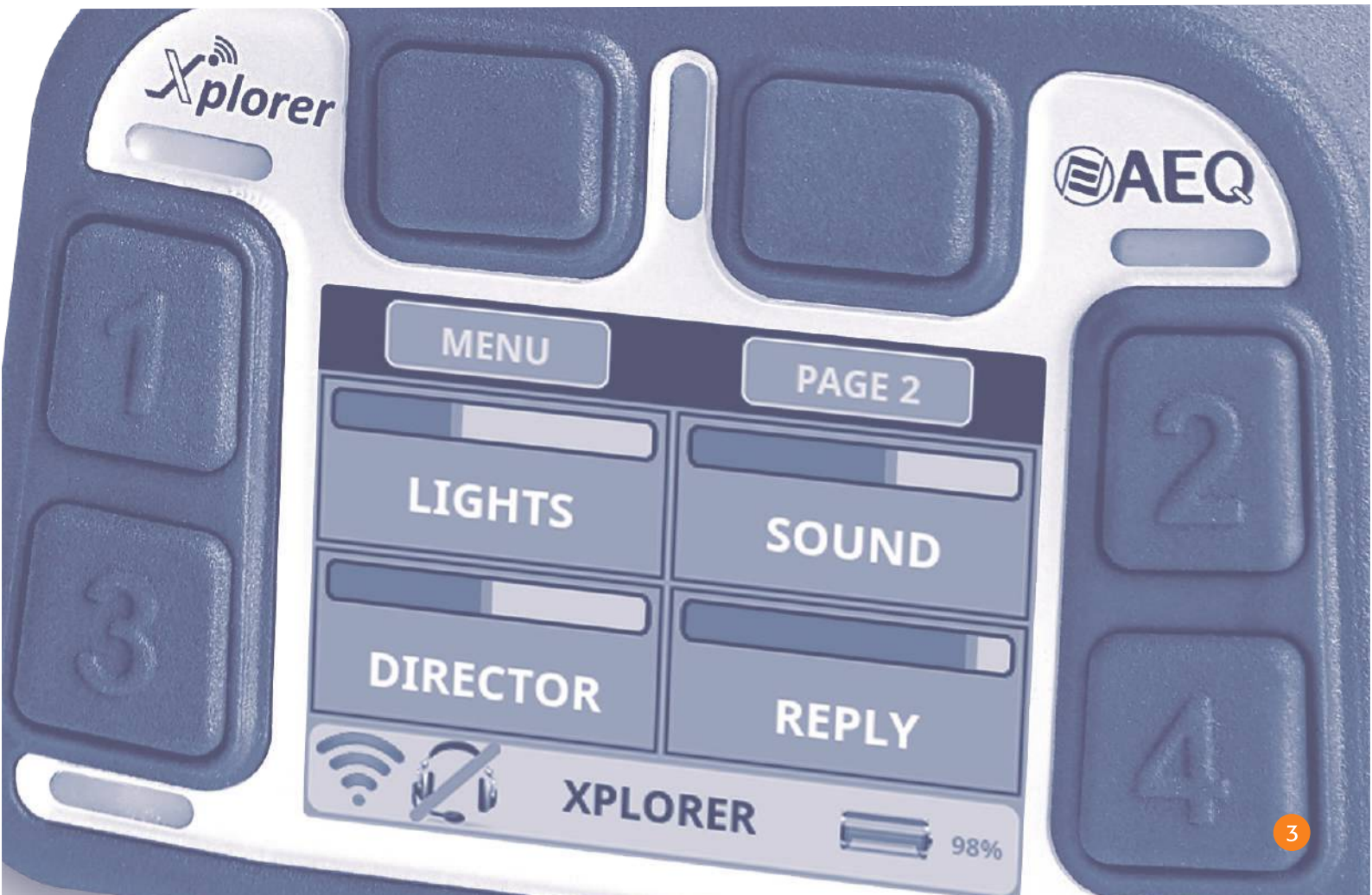



SECTION 1. INTEGRATED SOLUTION - AUDIO AND COMMUNICATIONS



The **ConeXia** system can be defined as a truly global solution which is able to manage all of our audio communications and contributions. It is based on a broadcast matrix, and puts the widest selection of available audio formats at our disposal in a completely modular way, whereas the resources can be selected according to each system’s particular requirements. At the same time, this modularity can provide total system redundancy, so system controllers, audio crosspoint/processing cards and even simple or Multichannel I/O cards can have automatic back-up. The internal TDM bus makes the matrix grow to up to 1024 x 1024 ports. All these features build up a broadcast-quality system with 48 kHz sampling frequency and 24 bits resolution, with great robustness and flexibility to manage our audio and intercom system.



The ConeXia system structure is based on the XCORE audio matrix, on a 4U 19” rack with three important system slots; at the front, the slots for the audio processing and communications crosspoints DSP cards are located. These tasks are performed dynamically, so backup cards for automatic function failover can be inserted. There are a total of 20 slots of this kind that may be populated depending on the system size and requirements.

There are another two types of slots at the back. Two of them are dedicated to the system controller card and optional redundancy. The remaining 21 slots, are for input/output cards for the different required audio formats. There is an internal back-panel in the middle of the unit that acts as an interconnection and TDM-bus transmission media for the 1024 channels of the system.

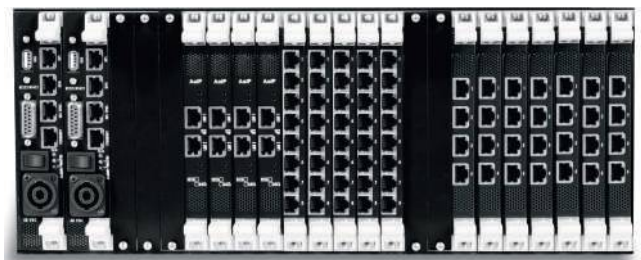

ConeXia Master is a higher-level management system that allows for the control of the whole intercom layer, distributing the crosspoint orders according to the user-defined configuration map. Consistently with the system philosophy and robustness, two units can be connected simultaneously in “mirror” mode to provide inherent redundancy.



Through an API, the Intercom Systems can be controlled from other applications. Control of AEQ Audiocoders and Telephone Systems have also been developed, allowing the remote access for applications and intercom user panels.



100% REDUNDANT

The integration of different systems, the large number of signals to manage, and the fact that communications are so critical during productions, demand that everything is covered in a system of this kind in order to avoid any unexpected issue. That's why Conexia offers solutions which provide reliability to every requirement.

REDUNDANT LINK SYSTEM DESIGN

A large Conexia matrix-based installation can be deployed as a distributed system or as a pool of smaller matrixes operating as if they were a single one. This requires that the information flow between the different blocks is always present. Conexia redundant link communication is the perfect solution, not only due to its inherent reliability, but also because it is possible to implement it using any of the Multichannel audio links included in the system.

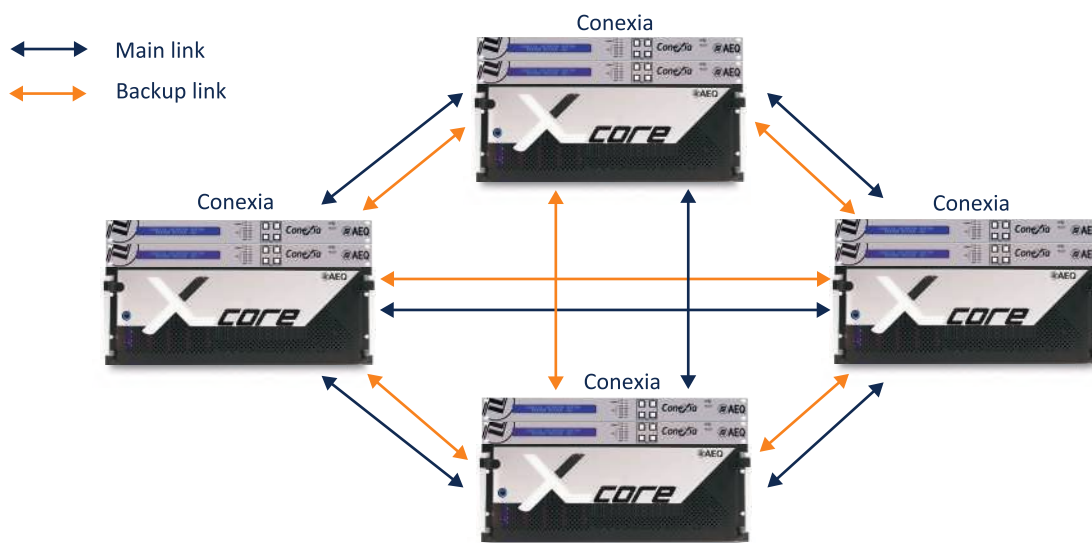

INTEGRAL MANAGEMENT OF MULTIFORMAT AUDIO AND INTERCOM

Conexia is an open system allowing for the interconnection to other equipment using analog or digital audio or multichannel audio links, with interfaces such as AES10-MADI, DANTE / AES67 / SMPTE ST 2110-30, RAVENNA / AES67 / SMPTE ST 2110-30 / SMPTE ST 2110-31, 3G-SDI, compatible with any other devices featuring these protocols. These communications can be made absolutely reliable as the system allows for redundant connections with automatic audio failover.

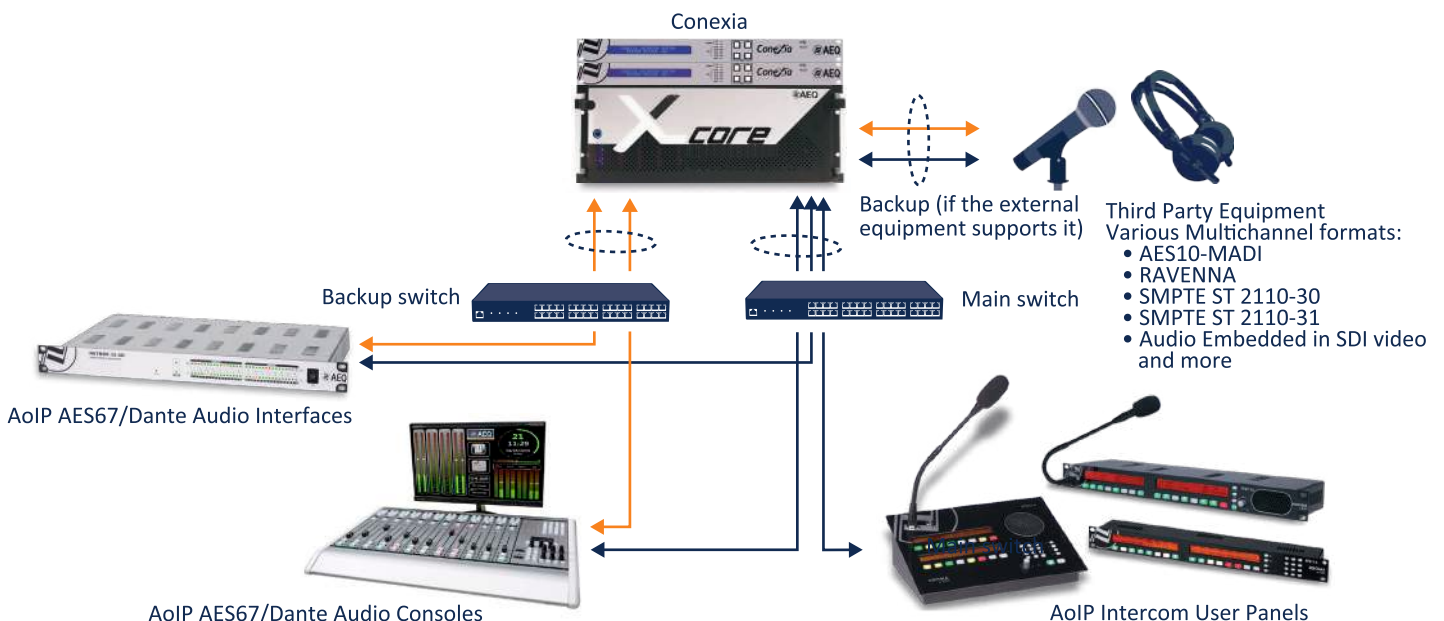

I/O INTERFACES

Based on a broadcast-grade audio matrix, Conexia system provides the widest variety of I/O interfaces available in the market. Besides, its modular structure allows us to develop new system input and output modules according to technical evolution. Not only the usual intercom system audio quality standards are offered, but any format available in our system can be used. These are the most commonly used interfaces in X_CORE matrix based systems:



XC02

AES/EBU Digital input/output module. 4 stereo I/Os which can be individually configured as SPDIF. Also features 4 GPIO.



XC03

Microphone/line input module with electronic balancing and Phantom power supply.



XC03H

Microphone/line input module with electronic balancing and Phantom power supply plus two high or low impedance headphone outputs. It occupies two slots in the backplane.



XC09

Electronically balanced, analog line input/output module. Provides 8 input and 8 output ports.



XC10

I/O Module providing digital connectivity for KROMA Legacy Intercom User Panels. This card provides connectivity for up to 8 digital Intercom User Panels to the routing matrix.



XC11

64 channels AES10 MADI multichannel module. SFP port. Can be fitted with long-range fiber optic transceivers.



XC12

Dual 2x64 channels AES10 MADI multichannel module. SFP port. Can be fitted with long-range fiber optic transceivers.



XC13

Link module for 1016 audio channels. Two systems or nodes can be linked together through optical fiber. SFP port, can be fitted with long-range transceiver modules.



XC18

Dual 3G-SDI card, with audio de-embedder and embedder for SDI video streams. Provides up to 2x16 audio input and output channels to the X_CORE bus.



XC19

VoIP intercom module with G.722 encoding. Provides 12 HD audio channels for Xplorer wireless belt-pack Systems.



ConeXia

AoIP INTERFACES



XC24

A DANTE™ /AES67 multi-channel AoIP Networking card for connectivity of up to 64 audio input and output channels.

XC24 FUNCTIONAL DESCRIPTION

XC24 is used to seamlessly interconnect AEQ devices. It also connects third-party, Dante-native and AES67 compatible devices. This latter may require previous configuration and setup.

When the AoIP Channels of the XC24 card are configured in the Dante ecosystem and using the Dante Domain Manager, it can also exchange audio with hybrid IP audio-video systems based on the SMPTE ST 2110-30 standard.



XC34

A RAVENNA /AES67 multi-channel AoIP Networking card for connectivity of up to 128 AoIP audio input and output channels .

XC34 FUNCTIONAL DESCRIPTION

XC34 is used to seamlessly interconnect the system with third-party, RAVENNA -native devices and AES67 compatible devices. This latter may require previous configuration and setup.

It can also exchange audio with hybrid IP audio-video systems, based on the SMPTE ST 2110-30 and SMPTE ST 2110-31 standards with NMOS control protocol.



AUDIO PROCESSING MODULES

Up to 20 XC21 or XC22 processing cards can be installed in each frame. One DSP card needs to be installed to perform each type of process.

The type and quantity of required DSP cards in each frame is calculated as a function of the number of input/output cards, output sum-buses, number of signals to apply dynamic, frequency, reverb processing to, delays (and their maximum time), as well as the number of vu-meters to represent.



XC21

DSP card designed to carry out audio processing and routing. This card allows the system to establish cross-points and perform signal processing, such as: equalization, compression-expansion, VU-meters and delay.

XC21 PROCESSING CAPABILITIES DETAILS

XC21 DSP can perform 4 types of audio processes:

- ROUTING: used to create cross points between input and output channels.
- MIXING: used to sum input channels to an output bus.
- TEST SIGNAL GENERATION AND VUMETERS:
 - Tones, pink and white noise generation
 - Signal and peak level measurement.
- SIGNAL PROCESSING:
 - Frequency: 4-band parametric EQ low pass, high pass and band-pass filtering.
 - Dynamics: compressor, limiter, expander, noise gate and DLP.
 - Delay
 - Reverb

In order to implement one or more processes of each type, at least one card per type of process is required. Also, a backup XC21 card can be added and configured as a backup Card. This card will automatically assume the function of any of the other XC21 cards in case of failure.



XC22

DSP card for the more demanding processing types of mixing and routing.

XC22 FUNCTIONAL DESCRIPTION

XC22 can perform 2 types of processes:

- ROUTER: used to create cross-points between input and output channels. It also allows to adjust levels for input and output channels as well as for the cross-point.
- MIXER: used to sum input channels to an output bus.

XC22 cards are used instead of XC21 when one of the above processes are used massively in a system. Also, a XC22 card can be added and configured as a backup Card. This card will automatically assume the function of any of the other XC22 cards in case of failure.



CONTROLLER MODULES



XC40

Main Controller Module for each frame. Two modules can be installed for redundancy.

XC40 card controls the frame configuration and its “relations” with the outside world. It also handles synchronization, alarms and the power supply of the frame.

It features an Ethernet connection to create a system control cluster.

It has 7 optically-coupled GPI plus 7 relay-operated GPO and incorporates the frame’s non-volatile memory for the configuration and operation of the X_CORE routing matrix.

CONEXIA



Intercom Super-controller in 1U rack format. Two ConeXia devices can be connected in mirror mode to achieve redundancy.

It controls the configuration of a whole intercom system based on X_CORE matrices. It communicates with all the XC40 controller modules in each of these X_CORE frames through an Ethernet connection.

ConeXia incorporates the non-volatile memory for configuration and operation as an Intercom System.

POWER SUPPLY AND FORCED COOLING UNITS

XC93



Redundant 800W power supply with hot-swappable cartridges. External unit with 2RU that provides power for up to 5 X_CORE frames (depending on their configuration).

XC95



Redundant 350W power supply. External unit with 1U rack height. It is designed to be placed on top of the X_CORE frame to improve the forced ventilation to evacuate the heat generated inside the X_CORE.

XC96



Forced cooling tray with air extraction at the rear and air intake at the front. XC96 should be installed when XC93, XC90 or XC 91 power supplies are used. If a single X_CORE is placed inside a rack, the XC96 needs to be located underneath the X_CORE. If two frames are installed, the XC96 unit has to be installed between the frames. For larger configurations, please ask for quantity of cooling trays and their recommended type and position.

XC90



Redundant 300W power supply with hot-swappable cartridges. External unit with 2RU that provides power for a X_CORE frame.

XC91



300W power supply. External unit with 1U rack height that provides power for a X_CORE frame.

XC97



Ventilation unit with front exhaust, to be installed when using XC93, XC90 or XC91 power supplies. To be placed under the X_CORE frame to improve the forced ventilation.

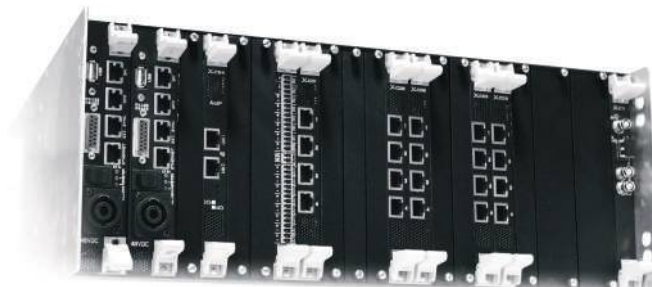



CrossNET is a compact and integrated Intercom solution. In a single height rack unit, we count on a matrix which is mainly based on Dante™ Audio over IP technology, also compatible with AES 67 and is able to manage up to 190 x 190 audio channels with internal, broadcast-quality audio processing.

Thanks to its scalability, from 40 x 40 to 190 inputs and outputs, the system offers a range of external direct connections: analog and digital ports, AoIP Dante™ and low bit-rate VoIP. The largest expression of the CrossNET Matrix is a 190x190 audio channels Intercom Matrix with the following port distribution:

- 12 four-wire, broadcast-quality, balanced analog audio ports for general purpose connections to external circuits such as audio consoles, I/O for PA, camera intercom or IFB's, etc.
- 8 digital audio ports (KROMA Legacy ports), providing backward compatibility with earlier KROMA systems, allowing the user to connect KROMA user panels from all series as well as interface cards.
- 20 low-bitrate KROMA Legacy VoIP audio ports that allow for the connection of remote user panels using narrow-band Internet connections, Xpeak desktop, rack and beltpack user panels, EasyNET party-line systems and, specially, the connection of Xplorer system for wireless beltpacks and virtual panels.
- Up to 128 Dante™ broadcast-quality audio over IP ports, that may be used to connect TP8000-series intercom user panels, Olympia 3 Commentary Units or whatever other compatible audio devices from more than 300 manufacturers using Dante™ and AES67 standards.
- 32 additional Dante™ broadcast-quality Audio over IP ports which may be used to connect Olympia 3 Commentary Units, mixing consoles, audio input/output interfaces, or whatever other compatible audio devices from more than 300 manufacturers using Dante™ and AES67 standards.

An integrated, small user panel

The front LCD screen, loudspeaker and micro-headphone input allows to use the proper Matrix as a small, 4-key user panel, which is always available to establish communications or monitor system audio channels where the matrix is installed.



SCALABLE TO EACH NEED

The CrossNET Matrix is available in the following versions:

CrossNET 40:

8 KROMA digital Intercom ports, 12 balanced broadcast quality analog audio ports and 20 ports for compressed audio over IP.

CrossNET 72:

32 Ports with Dante™ AoIP Interface, 8 KROMA digital Intercom ports, 12 balanced broadcast quality analog audio ports and 20 ports for compressed audio over IP.

CrossNET 104:

64 Ports with Dante™ AoIP Interface, 8 KROMA digital Intercom ports, 12 balanced broadcast quality analog audio ports and 20 ports for compressed audio over IP.

CrossNET 136:

96 Ports with Dante™ AoIP Interface, 8 KROMA digital Intercom ports, 12 balanced broadcast quality analog audio ports and 20 ports for compressed audio over IP.

CrossNET 168:

128 Ports with Dante™ AoIP Interface, 8 KROMA digital Intercom ports, 12 balanced broadcast quality analog audio ports and 20 ports for compressed audio over IP.



Compact Intercom Matrix

CrossNET

MAIN SYSTEM FEATURES:

- **The matrix can be expanded following user's requirements.**

The system can be expanded by adding Dante™ IP expansion port cards, starting from any of the intermediate sizes of a CrossNET matrix.

- **Adjustable audio levels.**

CrossNET allows for independent input and output audio level control for each port, as well as for level control of the established crosspoints.

- **IFB's.**

The system offers several possibilities for IFB that are implemented by the matrix and configured through the Crossmapper Intercom Matrix Software. Modes range from complete interruption to different levels of audio signal attenuation.

- **PSTN / ISDN / GSM / VoIP / SIP calls.**

The matrix is able to directly manage calls and dialing for Public Switched Network Telephone Networks, ISDN, GSM, or SIP based VoIP calls using compatible AEQ audiocoders and IP telephony systems, for both audio coordination and contribution. You only need to define the cards or devices as interfaces in the configuration.

- **Xplorer wireless system base station.**

The CrossNET matrix itself allows for the creation of an Xplorer wireless-beltpack or Xvirtual virtual-panels infrastructure, by means of a 2.4 / 5 GHz WiFi managed access point network that can operate in roaming mode.

- **An integrated, small user panel.**

The front LCD screen, loudspeaker and micro-headphone input allows to use the proper Matrix as a small, 4-key user panel, which is always available to establish communications or monitor system audio channels where the matrix is installed.

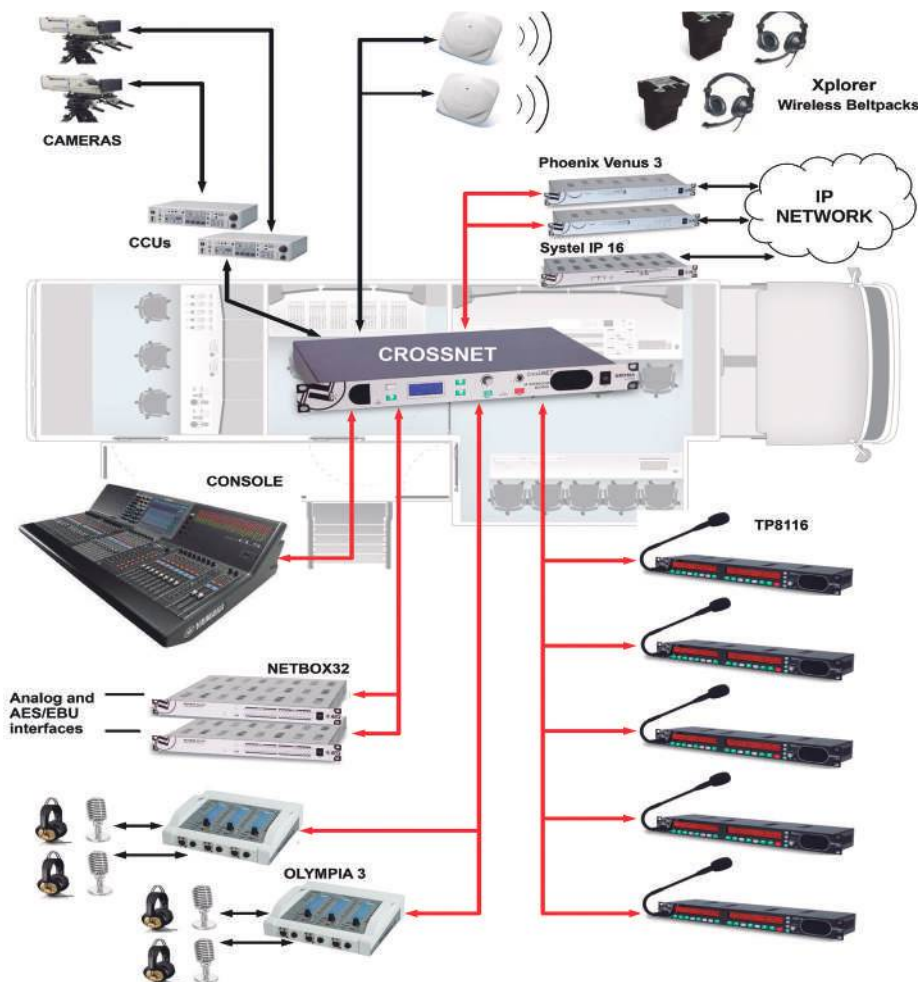

TP9000 WIRED INTERCOM PANELS FOR CONEXIA AND CROSSNET SYSTEMS

The TP9000 series user panels have been designed to achieve the high level of broadcast compatible audio quality that the digital technology of the Conexia and CrossNET matrices allow. Audio is digitised and processed at 24-bit 48 kHz (20 Hz to 20 kHz bandwidth) and negligible distortion and noise levels. Ease of installation has also been taken into account, so they incorporate IP connectivity that handles high quality audio in DANTE™ format, compatible with the AES67 standard.

They integrate a DSP that allows us to process the audio digitally to cancel the acoustic echo and automatically level the voice power or tonality and speech habits of each operator. The acoustics have been carefully studied to achieve the best intelligibility and natural sound.

TP9116 TERMINAL

FRONT PANEL

Talk and listen functions and individual volume control for each communication point, through a lever-type 4-way key. 16 crosspoint keys, four pages. Information is presented on four RGB graphic displays. Offering broadcast audio quality. 1 rack unit format.



TP8000 WIRED INTERCOM PANELS FOR CONEXIA AND CROSSNET SYSTEMS

Compatible audio quality that the digital technology of the Conexia and CrossNET matrices allow. 8000 series has the same outstanding features as the 9000 series.

TP8116 and TP8416

Rack-mounted and desktop user panels with 16 programmable keys arranged in 4 different pages.

FRONT PANEL

At the front panel, an electret “goose-neck” microphone and internal loudspeaker. 4-pin Mini-XLR (Tini QG) connector for micro-headphones. 16 cross point keys, up to 4 pages per key.

All the info is shown in a graphic display with up to two text lines per key, plus a third line indicating the crosspoint’s audio level.

Cross-points are indicated through key illumination. Additional keys for configuration. Rotary encoder for listening level adjustment and configuration. Listening level adjustment is available independently for each cross point.



TP8116 1RU User panel. with 120mm depth.

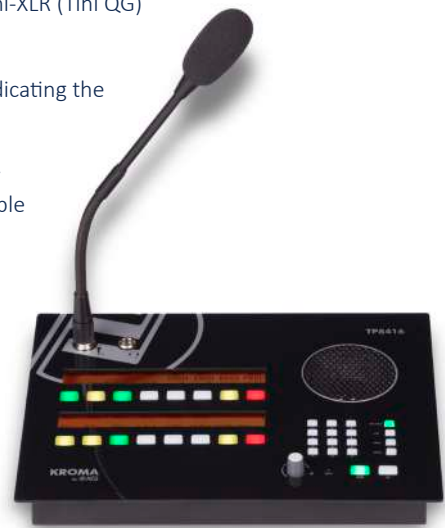

TP8416, desktop or flushmounted user panel 280x205mm. 80mm depth.

EP8116

19" rack 1U extension panel with 16 programmable keys organized in 4 different pages and numeric keyboard.

This panel provides a numeric keyboard for an easy calling management through the systems telephone interface. Also features a loop input / output that allows the connection of up to three extension panels to the same user panel.



EP8116 1RU Expansion panel. 80 mm depth.

TP9000 and TP8000 WIRED INTERCOM PANELS FOR CONEXIA AND CROSSNET SYSTEMS

COMMON FEATURES

PANEL SLOTS AND PANEL CONNECTIONS SPECIFICATIONS

Series TP8000 panels features the following connection ports:

- Dual high-quality AoIP connection in Dante™ format allowing us to connect the panel to different systems or create redundancy of the system.
- Compressed VoIP audio connection offering low binary rate to allow for remote connections through the Internet public network.
- A digital audio port with private protocol, for point-to-point connections (8 panels per XC10 card in Conexia, or 8 panels per device in Crossnet).
- A broadcast quality analog input / output audio port, allows for the connection to any external piece of equipment or system to send audio to the matrix, or to extract audio from it.
- One GPI and one GPO.

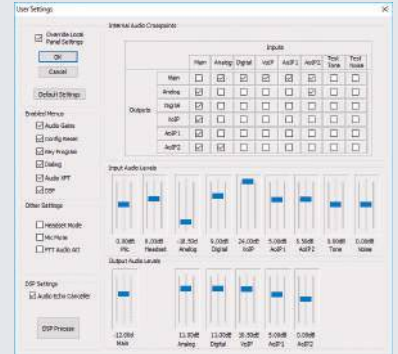

TP9116



TP8116



EP8116



TP8416

9000 and 8000 series rear panels

EXPLANATION OF THE DSP FUNCTIONS

The TP8000 panels features built-in DSP providing the following audio processing:

- Echo cancelling to avoid local feedback and potential returns.
- 3-band parametric equalizer with high-pass and low-pass filters in order to adjust audio brightness and choose the best compromise between vocal comprehension and clarity of sound.
- Dynamics control:
 - Compression, for a wide range of distances and angles to the microphone.
 - Expander and noise gate, to eliminate or minimize room ambient noise.

- Noise gate allowing us to provide sound to the user panel with the best possible listening environment for our communication. Includes internal audio test generators (1 kHz @ -20 dBFS tone, pink noise @ -20 dBFS).

It provides a replay function allowing the user to play back the latest 16 seconds of audio emitted by the speaker / headphones.

The audio setup is managed through the “Crossmapper” software. There are standard user profiles provided by default, but it is possible to modify, adapt or create new ones with specific requirements.

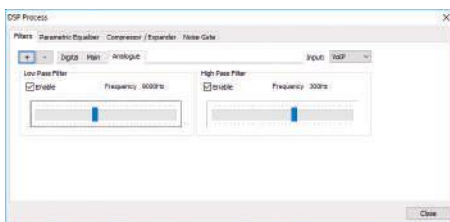

Filter adjustment



EQ adjustment



Compressor / Expander adjustment

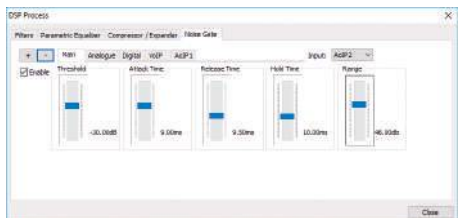

Noise gate settings

OLYMPIA 3

OLYMPIA 3 COMMENTARY UNIT

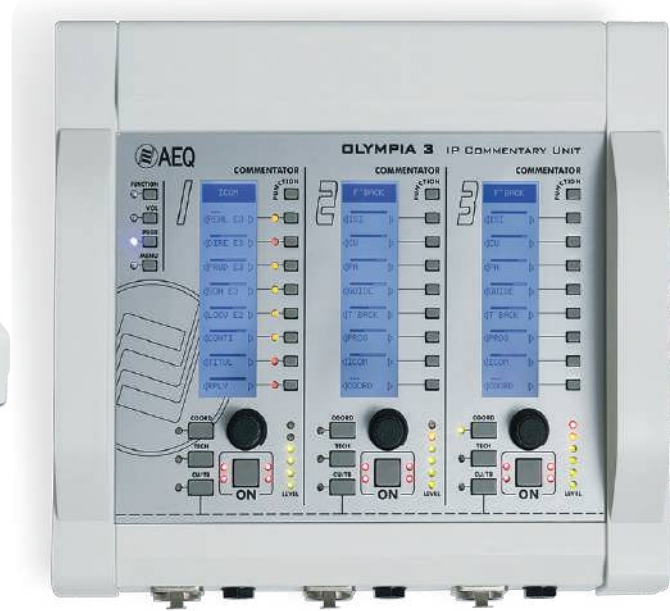

Operates as an Intercom Panel and a Commentary Unit at the same time

Olympia 3 represents a breakthrough in the development of this kind of systems, as it can operate standalone or for example in a mobile unit and integrated with an Intercom System. Even if in essence it is a Commentary Unit, it can operate as an Intercom Panel.

The OLYMPIA 3 can be operated in a hybrid mode, having two simultaneous functions:

An Intercom User Panel:

- For this mode, the channel “COMMENTATOR 1” includes the required functionality and signaling to be able to operate as an Intercom channel. When operating as an intercom panel it provides the same level of functionality as the KROMA by AEQ series-8000 user panels.

Commentator 1 channel assumes the functions of an intercom panel. The display corresponding to channel 1 will adopt the “Intercom mode” and the keys will adopt the programmed intercom destinations or functions and the associate microphone and headphone will form part of the Intercom System.

A Commentary Unit:

- The OLYMPIA 3 CU CONTROL application configures and controls the CU except the circuit that Commentator 1 is using as its intercom circuit and when operating in this Intercom mode.

Outstanding features:

- Standalone commentary unit (CU), or AoIP connected with 8 channels via Dante™ protocol. Scalable architecture: simple routing to Dante™ IP devices; integrated in IP Intercom System, or connected to IP Commentary System Matrix.
- Standalone mono or stereo sound mixer with mixing, routing, tone and dynamics control. 3 commentator inputs and a dual-mono or stereo line level input. Listening of 8 remote and 2 local sources.
- Operates as an Intercom Panel at the same time as a Commentary Unit.
- Configurable as interpreter desk up to three languages.
- 3 1Gigabit IP ports per unit for redundancy, daisy chain and auxiliary data or video transport.
- Dual power supply: 48 VDC via PoE or external local power supply.
- Software Configuration and remote control.
- Rugged and ergonomic mechanics, suitable for indoors and outdoors locations.
- Dimensions: 280 x 200 mm. Depth. 80 mm.





INTERCOM USER TERMINALS WITH VOIP HD AND KROMA VOIP CONNECTIVITY

Compatible with Conexia and Crossnet matrixes. With Conexia: 20 Hz to 7KHz bandwidth. Up to 12 terminals per XC 19 card. With Crossnet: 20 kHz to 4 KHz bandwidth. Up to 20 terminals per matrix.



Xpeak R and Xpeak D

Rack-mounted and desktop user panels with 8 programmable keys arranged in 4 different pages.

FRONT PANEL

At the front, we can find a “gooseneck” electret microphone and internal loudspeaker, a front USB connector for micro-headphones, 8 cross point keys -operating with the matrix, up to 4 pages per key can be programmed- and 2-axis, lever-type keys, allowing the user to control talk and listen and individual volumes for each communication cross point. Information is presented on two LCD graphic screens and RGB LEDs associated to the keys. Rotary encoder and configuration keys.



BACK PORTS AND CONNECTIONS

At the back, two VoIP ports for loop connection, USB (type B) connector for connection to headphones and PCs. GPIO: connector with 2 optically coupled GPI and GPO and a power pin to supply external circuits. Internal power supply.

Bluetooth: the device incorporates Bluetooth connection as an audio interface with a telephone or micro-headphone.

It can combine different audio signals arriving to the system from different devices.

Eco-cancellation processing.

Xpeak R, 1 RU User Panel with 103 mm depth.

Xpeak D, desktop or embeddable User Panel, 217 x 105 mm. 101 mm depth.





Xpeak BP

Wired beltpack User Panel with 4 programmable keys in 4 different pages.

FRONT PANEL

On the front, 4 cross point keys can be found. When operating together with a matrix, up to 4 pages per key can be programmed.

The rest of contextual information associated to keys, the communication and the menu are presented on a graphic LCD screen which can be turned on and off.

Also at the front, two lock, mute, page swap and menu navigation keys can be found.



BELTPACK'S BACK PORTS AND CONNECTIONS

Ethernet VoIP port and PoE supply on a RJ45 latching connector. Back USB port for micro-headphones. Two-pin GPO output.



OTHER FEATURES

Two rotary encoders for volume adjustment. Bluetooth interface for audio exchange with telephones or micro-headphones. It can combine different audio signals arriving to the system from different devices. Eco-cancellation processing.

Mechanics: Belt-pack is made of shock-proof plastic. Dimensions: front: 82mm wide, 70mm depth, 130mm height.

Functions: incoming call front signalling with the possibility to activate GPO to external devices.





Xplorer

WiFi 5G technology allows for operation of this kind of systems in any environment, as it works in a free and non-saturated frequency band. Installation and system power up is really easy since this technology is well-known and already implemented in any of your installations. Reusing your existing wireless network is possible, only having to ensure that the QoS is guaranteed.

Nowadays, WiFi systems including managed access points provide “roaming” functionality, offering wide, seamless coverage within the entire network. This provides flexibility in production its and resource requirements without the need to reconfigure devices or pair every Beltpack to the different antennas, which becomes tedious.

Xplorer Beltpack

INTERCOM USER TERMINALS WITH VOIP HD AND KROMA VOIP CONNECTIVITY

Xplorer is more than a beltpack, it’s an authentic wireless intercom user panel. Based on Wi-Fi technology, it is equipped with a 4 shortcut keys user interface -arranged in pages-, another two programmable keys, and a multifunction screen.

Wireless beltpack format with 4 programmable keys in 4 different pages. Compatible with Conexia and Crossnet matrixes. With Conexia: 20 Hz to 7KHz bandwidth. Up to 12 terminals per XC 19 card. With Crossnet: 20 Hz to 4 KHz bandwidth. Up to 20 terminals per matrix.

FRONT PANEL

On the front, 4 cross-point keys. When operating together with a matrix, up to 4 pages per key can be programmed.

The rest of contextual information associated to keys, the communication and the menu are presented on a graphic LCD screen which can be turned on and off. Also at the front, mute, page swap and menu navigation keys can be found.



BELTPACK BACK PORTS AND CONNECTIONS

Mini XLR back connectors for micro-headphones. Charge connector.

OTHER FEATURES

Two rotary encoders for volume adjustment. Eco-cancellation processing. Muting function. Ethernet network connectivity using WiFi. Compatible with 802.11b/g/n networks in the 2.4GHz band and 802.11a/n networks in the 5 GHz band. Powered by rechargeable batteries providing up to 20 operating hours. Charged at the charge station.

Mechanics: Beltpack is made of shock-proof plastic. Dimensions: front: 92mm wide, 70mm depth, 130mm height. Approx weight: 365g.





XVirtual

Xvirtual

INTERCOM USER APP FOR PC, IPAD OR IPHONE WITH WIRED OR WIFI CONNECTIVITY.

Xvirtual, an application for iOS and Windows devices with the same functionality that can be found in a 16 keys Intercom User Panel, for Conexia and CrossNET intercom systems.

The application can be installed on a PC, with windows operating system, turning it into a User Panel and part of your Intercom System, only requiring a simple Ethernet connection.

In the same way, it can turn any Apple iPhone, iPod or iPad device, with iOS operating system, into a Wireless Intercom Panel. Just connect it to a Wi-Fi network providing access to a Conexia or Crossnet Intercom System to build your Wireless Beltpack System.

OTHER FEATURES

Compatible with Conexia and Crossnet matrixes.

With Conexia: 20 Hz to 7 KHz bandwidth. Up to 12 terminals per XC 19 card.

With Crossnet: 20 Hz to 4 KHz bandwidth. Up to 20 terminals per matrix.

Muting function.

Key functions. Functions have been defined for each key to allow for multiple operating modes, and signaling regarding the communication status is provided at each one.





AN EXAMPLE OF A MATRIX INTERCOM SYSTEM AT A THEATER

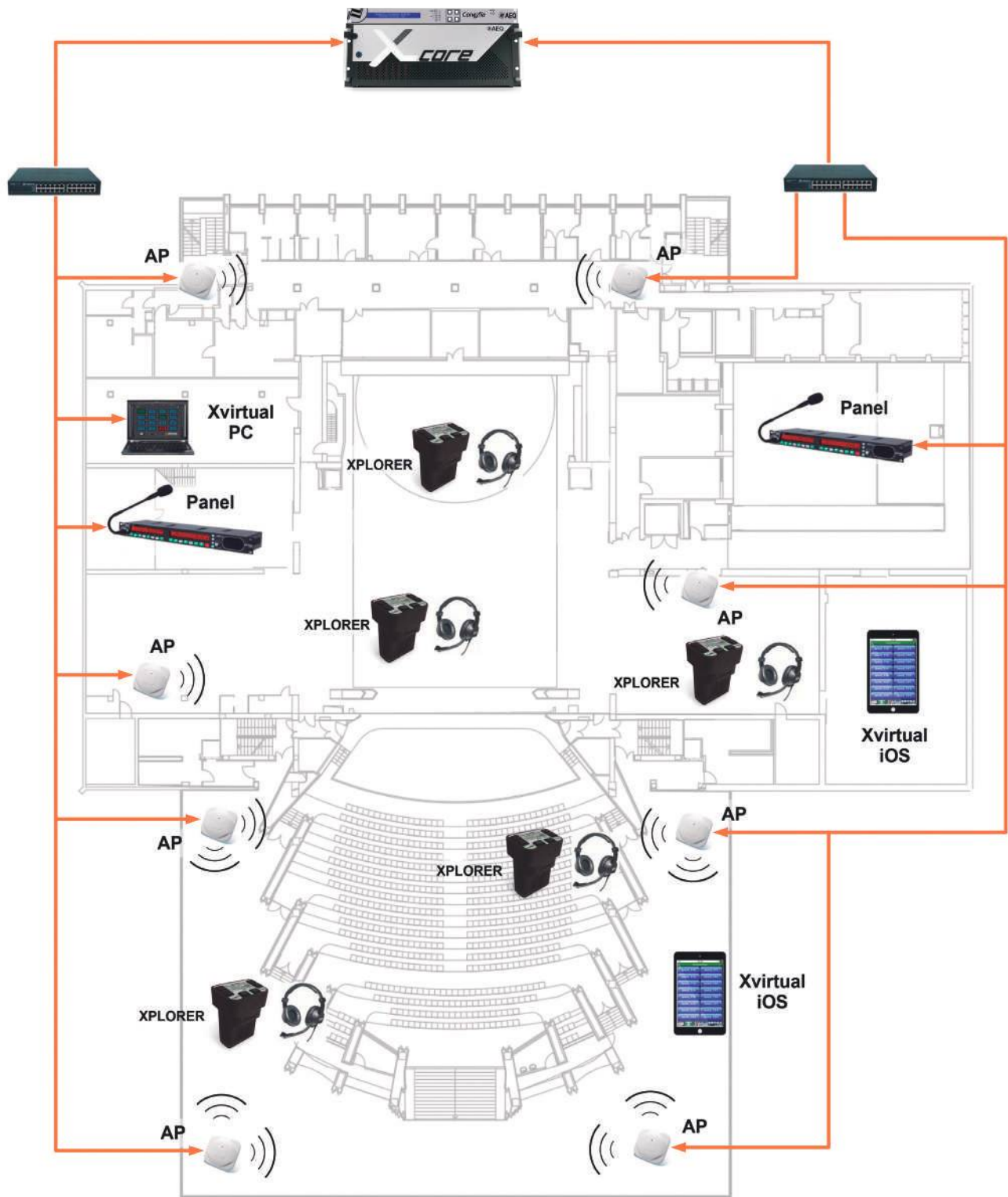

AUDIOCODECS AND INTEGRATED PHONE SYSTEMS

PHOENIX VENUS 4 and VENUS 4+

Dual, stationary, stereo and full duplex IP audiocoders for the most demanding applications.

Ethernet control from the intercom system. SMART RTP connection available. It has been designed to comply with the N/ACIP EBU Tech 3326 recommendation with the addition of OPUS coding. Dual ethernet port. Option to connect to the Dante TM system via a third IP port.

VENUS4+ adds front panel controls for the basic operation of the equipment including status indication and on-screen VU-meters. It also provides a menu to initiate and accept calls, execute presets and to edit/modify settings.



PHOENIX MERCURY

IP audiocoder, stationary, stereo and full duplex. Ethernet control from Intercom System. SMART RTP connection available. It has been designed to comply with the N/ACIP EBU Tech 3326 recommendation by adding OPUS coding.



SMARTALK SERVICE

PHOENIX VENUS 4, VENUS 4+ and MERCURY are compatible with Smartalk service. Smartalk service is a cloud-based audiocoder system that generates web links for PCs or Smartphones to instantly download an OPUS audiocoder from the cloud, which, through a SIP server, automatically connects to the studio's AEQ audiocoder.

This makes it possible to improvise access to remote users of an intercom system without the need for anything more than their own PC or smartphone, avoiding the need to have a dedicated equipment or download apps.



SYSTEL IP 16

The Systel IP16 also allows SIP calls/communications to become an integer part of the intercom systems, through SIP service providers, IP PBX, audiocoders, IP and PSTN (POTS) telephone systems. Also available for the Systel IP TV, a special application for intercommunication and technical coordination for broadcast production centres and Systelset+ operator's terminal.



DANTE™ /AES67 I/O INTERFACES

This NETBOX interface range allows us convert any digital or analog audio within the system to the DANTE™ – AES67 standards and make them compatible with the equipment of more than 300 manufacturers.

NETBOX 32 AD

DANTE™ interface with 32 input / output channels. Plugin for 16 analog audio channels and 8 digital stereo pairs.



NETBOX 8 AD

DANTE™ interface with 8 input / output channels. Plugin for 4 analog audio channels and 2 digital stereo pairs.



NETBOX 4 MH

DANTE™ interface with 4 high-quality microphone inputs and headphone outputs.





CROSSMAPPER

All AEQ-Kroma Intercom systems use a CrossMapper software for the setup. This software provides a user-friendly graphical interface and also offers a powerful setup capabilities, allowing total access to the setup, care and control of the system.

USER PANELS AND DSP CONFIGURATION

The user has an easy access to the setup for each intercom panel, with individual setup options for each key. Additional features such as groups management, conferences, telephone dialing, IFB's, etc are included. It is also possible to access to the I/O matrix internal set up for the different ports in each panel and adjust their input and output levels. The TP8000-series offers an internal setup for the DSP.

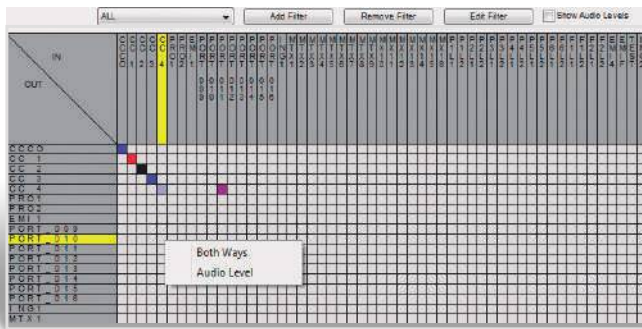
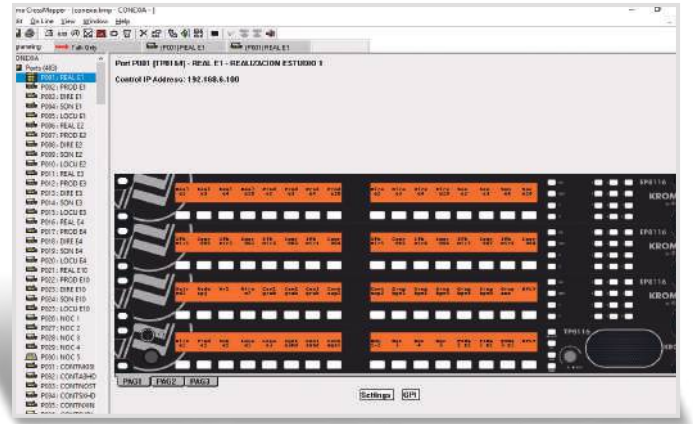

CROSSPOINTS AND AUDIO LEVELS

If we are connected online to the matrix, we can currently see all the established audio connections in the system on the spot. The "Crosspoint" menu allows us to make connections on-the-go. The same menu allows the adjustment of the audio level for each existing crosspoint and to see any possible change made by the users. It is possible to edit the different views to filter the users according to the particular needs.

CALL MANAGEMENT

AEQ-Kroma Intercom systems offer a huge range telephone interfaces: analog, ISDN, GSM, etc. CrossMapper can manage the dialed and received calls like in a phone PBX, able to identify, route or reject the calls. This will make the management of all our communications during operation much easier.

IFBS AND GROUPS

The system offers several IFB possibilities, such as a complete audio interruption or different attenuation levels. All these options are implemented in the matrix. The setup of any IFB can be used with any device connected to the system. It is also possible to generate groups so every software-created programming can be applied on all the group components at the same time.

SYSTEM STATUS

The CrossMapper is the perfect tool to control our matrix status and all the terminals and interfaces connected to the system. Using the System Status online menu, we can check currently the complete status of each connected component, as well as it's additional information. This grants us absolute remote control on the intercom system from any location.

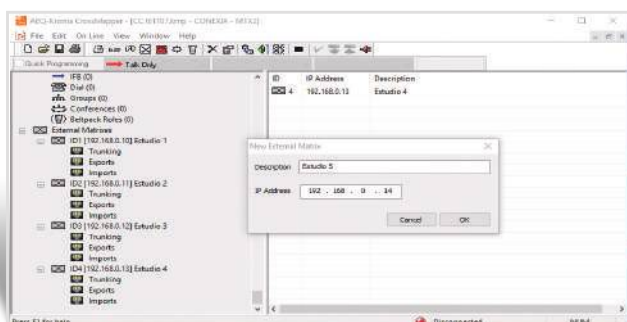
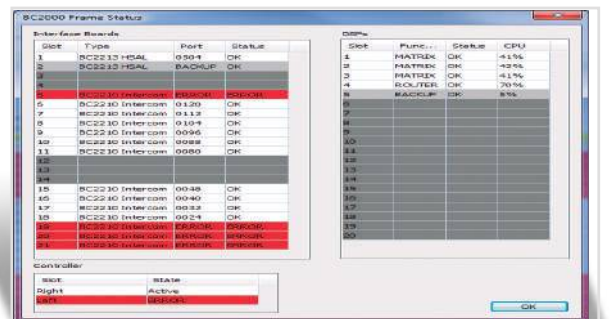

NON-BLOCKING TRUNKING

Our systems are able to connect to each other, building up larger systems where every user can have access to the rest of the systems without any limitation or restriction. The Trunking menu included in the software setup allows us to check and configure cross-points with any of the terminals and interfaces in the others Intercom matrices.

LIVE CROSSMAPPER

DYNAMIC OPERATION

Productions are getting more and more dynamic, so we need the proper tools to stay tuned.

Live CrossMapper is a multi-user tool that enable an easy online management of the matrix, allowing the reconfiguration of the intercom panels' keyboard without any influence for the rest of users that don't require constantly setup changes.

XPT MANAGER

It is impossible to foresee all the possible situations. That's why Live CrossMapper offers an easy, quick and user-friendly way to make online crosspoints between any panels or interfaces within our system. A simple mouse click will generate a new crosspoint.

XPT VIEWER

A fast and easy way to check the summary of the communications established with our matrix. A complete listing of our panels, the currently established cross-points, their setup and the audio levels currently programmed or modified. In essence, this tool provides a full control of our communications in a single screen.

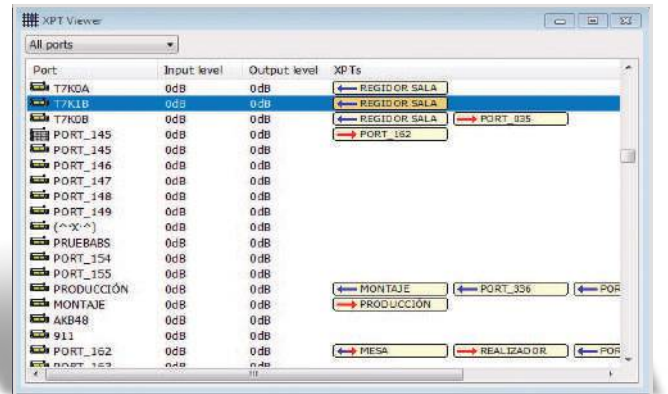
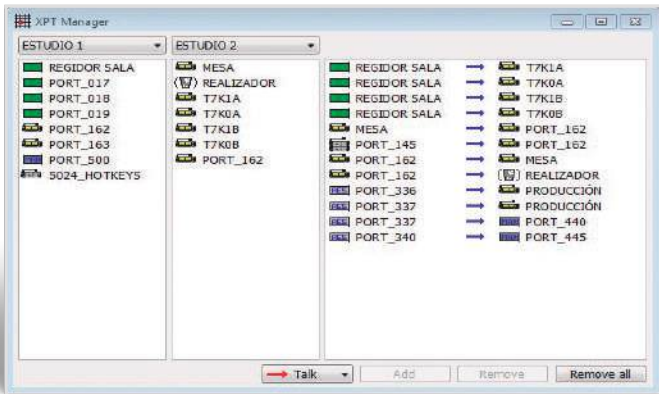

HOTKEYS

Intercom panels are no longer static: communications changing their destinations, live contribution changes...They need different setups in the same production, without affecting the rest of the panels. That's why we created reconfigurable hotkeys that allows us to quickly change assignments and tasks.

IFBs

The number of coordination circuits, generation of N-1 circuits, and management of return feeds always makes a setup operation complicated. Live Crossmapper turns into an essential tool as it provides a special screen for their management, that can be performed with just two mouse clicks.

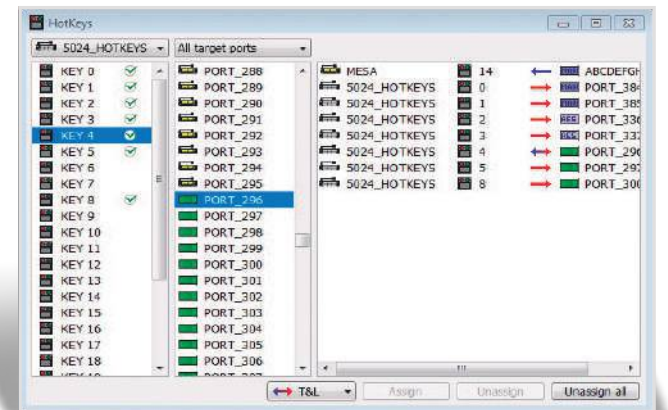
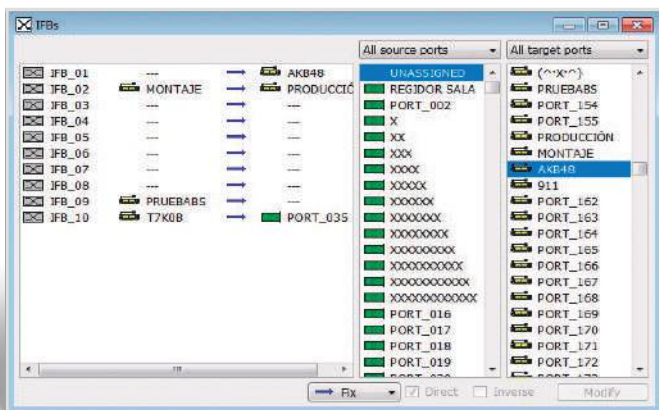

AEQ INTERCOM SYSTEMS

MORE THAN AN INTERCOM: A Global Solution for Audio, Communications and Intercom

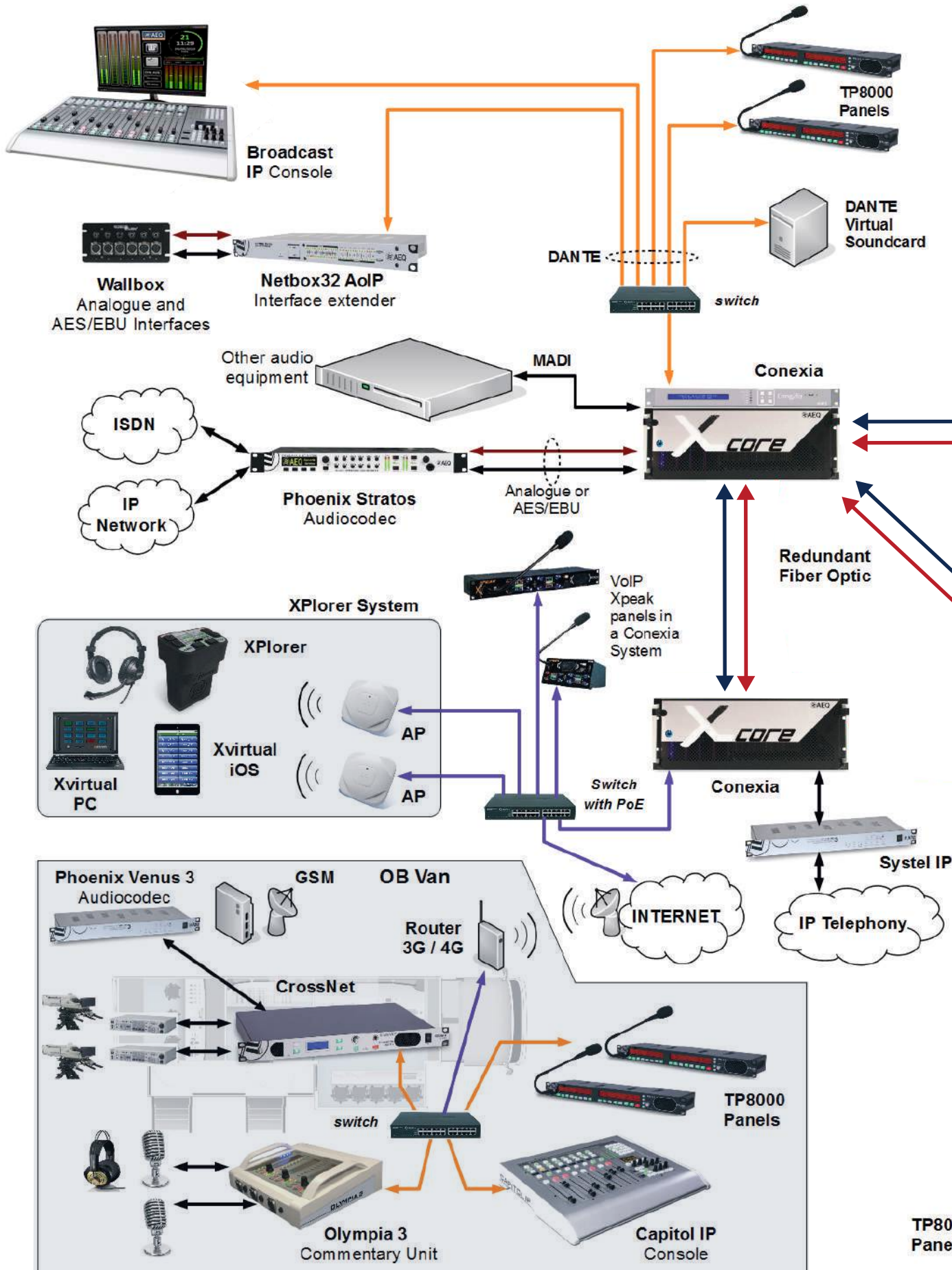

TP8000 Panel

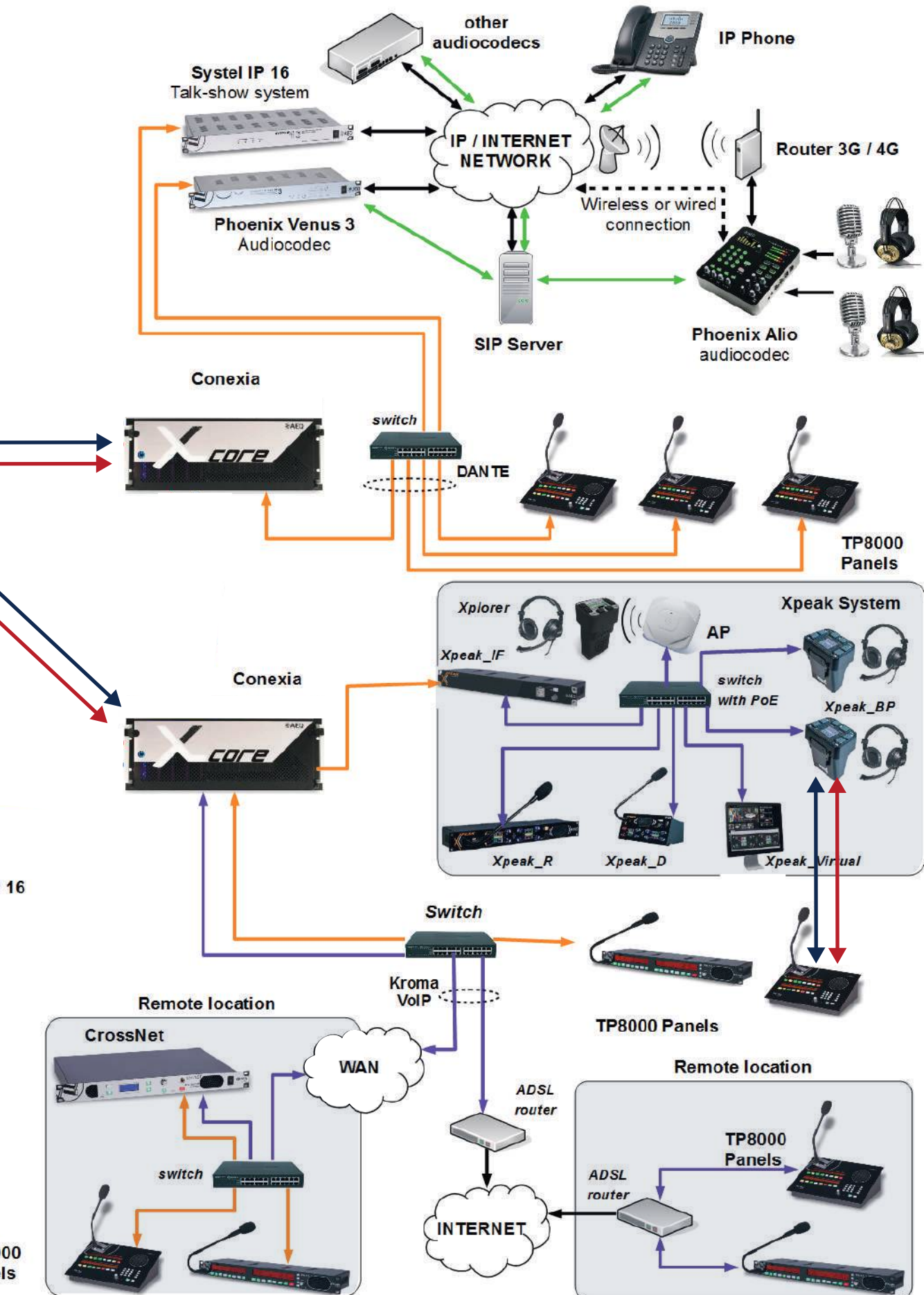

16

00
ls



SECTION 2. MATRIX-LESS, DE-CENTRALIZED INTERCOM SYSTEM

ESSENTIAL TOOL

In conventional AV/Media production, the intercom is an essential tool for the technical coordination of everyone involved: Directors, producers, camera operators, presenters, floor managers, Audio and Lighting teams, etc.

An intercom system is a mission critical tool that must neither fail nor be vulnerable to cyberattacks. Therefore, it must include advanced security features such as access control rules, security control, and traffic encryption.

REMOTE PRODUCTION

Remote production is nowadays a standard part of operations. The need to produce Television and Radio minimizing the mobilizing and remote deployment of technical personnel, has become a fact. It is now required that Production personnel is able to work from different locations, some of them temporary (hotels, stadiums, etc).

Until now, these situations have been resolved by connecting intercom systems to audio codecs and IP telephony systems

and configuring the systems separately, which involves the deployment of expensive systems and the development of complex connection and set-up tasks.

AUTOMATIC GLOBAL INTERCONNECTION

For this reason, we have created Xpeak, an intercom system that incorporates virtual network technology, through an automatic global interconnection Wizard. The Wizard avoids the difficulties of creating a virtual network and configuring the devices to work on it.

In Xpeak, different hardware or software user panels are interconnected as if they were all part of the same physical production center. It doesn't matter whether they are on the same LAN network, or if they are dispersed in different places with access to Internet – they will all connect.

You do not have to have a static IP, nor do you need a dynamic DNS, nor do you need to set port forwarding, because each user panel is automatically configured according to the local network of its location. It works immediately in all network environments, even on very restrictive networks.

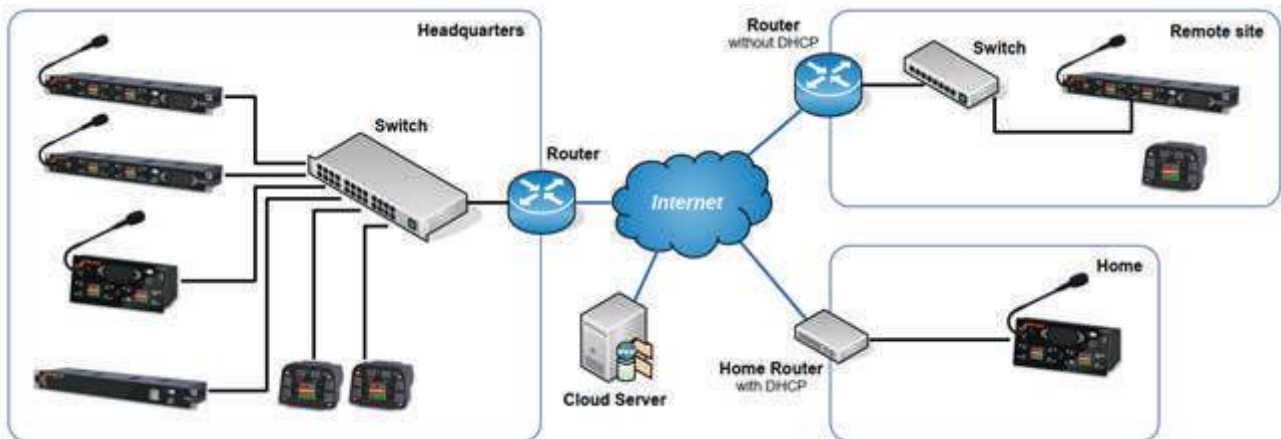

HOW IT WORKS

Xpeak Systems have the option of a Virtual Network or “tunnel” service to facilitate the automatic connection of panels located remotely, in different local networks, or isolated. Each of the devices that make up the system will simply need an Internet connection so that, in a completely transparent way to the user, they can operate with each other as if they were connected to the same physical local network.

A typical system might consist of several Xpeak devices operating at a single site, and one or several remote devices at residential or remote locations. The devices at the headquarters, to access the remote ones, must have an outgoing Internet connection, in order to reach the virtual network server in the cloud that will route the audio bidirectionally to the remote panels.

When the Xpeak devices have an internet connection, they are authenticated in the Xpeak Cloud Server, in charge of keeping a record of all the devices belonging to the same Virtual Network. The server allows visibility between all the devices that are registered in the same virtual network, and also routes the audio from the panels that are part of different local networks, through it.

Xpeak equipment leaves the factory registered to work in a Virtual Network. Unless otherwise indicated, all the devices in the same order are associated with the same Virtual Network.

The pre-defined virtual network may or may not be registered, depending on whether the Virtual Network License has been purchased. Each Virtual Network License is valid for one Xpeak System, which is limited to 28 user panels.

A virtual network license, or its update, can be activated at any time, by contacting AEQ. It is also possible to reassign user panels to a virtual network other than the initial one.



SYSTEM DEVICES



Xpeak_R User Panel



Xpeak_D User Panel



Xpeak_BP Wired Backpack



Xpeak_IF I/O Interface



Xpeak Virtual App for PC



Xplorer Wireless Backpack

Xpeak R and Xpeak D

Rack-mounted and desktop user panels with 8 programmable keys arranged in 4 different pages.

FRONT PANEL

At the front, we can find a “gooseneck” electret microphone and internal loudspeaker, a front USB connector for micro-headphones, 8 cross point keys -operating with the matrix, up to 4 pages per key can be programmed- and 2-axis, lever-type keys, allowing the user to control talk and listen and individual volumes for each communication cross point. Information is presented on two LCD graphic screens and RGB LEDs associated to the keys. Rotary encoder and configuration keys.



BACK PORTS AND CONNECTIONS

At the back, two VoIP ports for loop connection, USB (type B) connector for connection to headphones and PCs. GPIO: connector with 2 optically coupled GPI and GPO and a power pin to supply external circuits. Internal power supply.

Bluetooth: the device incorporates Bluetooth connection as an audio interface with a telephone or micro-headphone.

It can combine different audio signals arriving to the system from different devices. Eco-cancellation processing.



Xpeak R, 1 RU User Panel with 103 mm depth.



Xpeak D, desktop User Panel 217 x 105 mm. 101 mm depth.



Xpeak BP

Wired beltpack User Panels with 4 programmable keys in 2 different pages.

FRONT PANEL

On the front, 4 cross point keys can be found. When operating without a matrix, up to 2 pages per key can be programmed. Associated with each key there is an RGB LED to indicate the family to which the destination of each key belongs.

The rest of contextual information associated to keys, the communication and the menu are presented on a graphic LCD screen which can be turned on and off.

Also at the front, two lock, mute, page swap and menu navigation keys can be found.



BELTPACK'S BACK PORTS AND CONNECTIONS

Ethernet VoIP port and PoE supply on a RJ45 latching connector. Back USB port for micro-headphones. Two-pin GPO output.



OTHER FEATURES

Two rotary encoders for volume adjustment. Bluetooth interface for audio exchange with telephones or micro-headphones. It can combine different audio signals arriving to the system from different devices. Eco-cancellation processing.

Belt-pack is made of shock-proof plastic. Dimensions: front: 82mm wide, 70mm depth, 130mm height.

Functions: incoming call front signalling with the possibility to activate GPO to external devices.

Xpeak Virtual

User terminal implemented as a PC Software application with 8 programmable keys.





Xplorer

User Panel in wireless beltpack format with 4 programmable keys in 2 pages.

FRONT PANEL

On the front, 4 cross-point keys. When operating without a matrix, up to 2 pages per key can be programmed.

The rest of contextual information associated to keys, the communication and the menu are presented on a graphic LCD screen which can be turned on and off. Also at the front, mute, page swap and menu navigation keys can be found.



BELTPACK BACK PORTS AND CONNECTIONS

Mini XLR back connectors for micro-headphones. Charge connector.

OTHER FEATURES

Two rotary encoders for volume adjustment. Eco-cancellation processing. Muting function. Ethernet network connectivity using WiFi. Compatible with 802.11b/g/n networks in the 2.4GHz band and 802.11a/n networks in the 5 GHz band. Powered by rechargeable batteries providing up to 20 operating hours. Charged at the charge station.

Beltpack is made of shock-proof plastic. Dimensions: front: 92mm wide, 70mm depth, 130mm height. Approx weight: 365g.



Xpeak_IF



Audio format converter/interface for 4 audio inputs and outputs to 4 Xpeak bi-directional channels.

External channels can come in analogue, USB or Dante / AES67 AoIP format.

USB connection: The 4 USB audio ports are type B and allow you to connect audio from a PC.

Ethernet connection: internal switch with two external network ports. Different uses: daisy chain, separation between Dante audio and encoded audio + Control.

GPIO: Mini-Hartmann connectors include 4 opto-coupled GPIs and 4 GPOs with external power pin.

It features a TFT screen, rotary encoder and menu key for its configuration and control from the front panel, allowing for navigation through the user interface for easy configuration and status display.

General Features

ADVANTAGES OF XPEAK

1 Three modes of operation:

- **Virtual Matrix:** Xpeak obtains the flexibility of AEQ intercom systems without incorporating a matrix. Each panel maintains the cross-point programming according to its defined role.

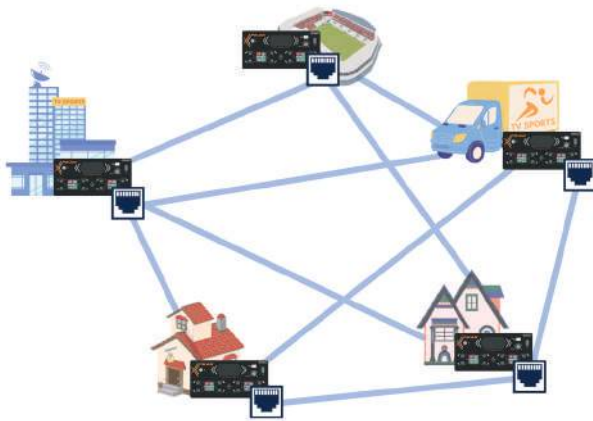

- **4 channel Party-Line:** Very simple configuration since it is only necessary to determine which channels each panel will talk to and which channels each panel will receive.
- **Physical Matrix:** The Xpeak panels works as a very cost-effective user-panels, with 8 physical keys (up to 32 virtual keys) in AEQ Conexia and Crossnet Matrix systems.

2 Wizard for automatic global interconnection

Simplify the use of virtual network technology to streamline remote productions.

3 The panels do not belong permanently to a specific system:

- The same user panel can work on multiple locations.
- The same panel can be part of different intercom systems.
- Possible expansion of the system through the cloud in a subscription-by-use scheme that does not require acquiring resources that are not used regularly.

4 User terminals that support Bluetooth and USB micro-headsets.

Compatible with a wide range of headsets with excellent value for money.

5 User panels that can be connected to PCs and Smartphones.

Via Bluetooth and USB connectivity.

6 Great audio quality with low bit rate

It allows incorporating remote terminals through different connection methods.

7 Stationary panels can be connected in Daisy Chain.



BASIC FUNCTIONALITY IN DETAIL

- System dimensions: Up to 28 user terminals or external inputs and outputs.
- Two working modes:
 - Intercom mode in which each key of a user terminal can be configured with the same functions as in a system with an AEQ matrix.
 - 4 channel Party-line mode, which hardly requires any configuration.
- Intercommunication between the members of a domain regardless of their location. The panels can work in a local LAN network or in a WAN network that can be global in nature through the internet. In this case, intelligent connectivity is available through virtual network technology, through an automatic global interconnection wizard, which simplifies configuration, discovering the elements of the system within the domain. Connection without opening ports in routers, to use terminals in locations such as hotels, homes, or others without access to a support technician.

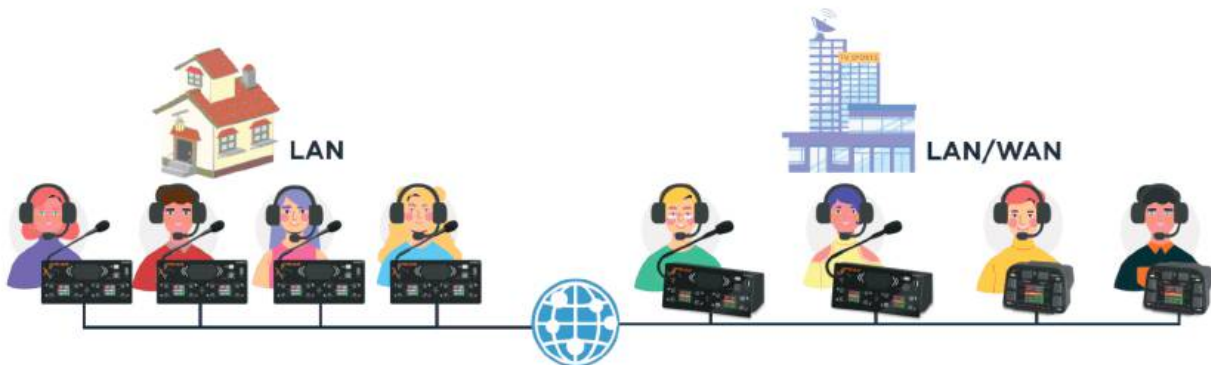

- Virtual network architecture allows a device to subscribe to different virtual networks on demand as needed.
- The system and its elements are compatible with previous intercom systems bearing the AEQ and KROMA brands.
- System is configured from the user panels themselves. There is also an optimized configuration tool, online and offline, for the most complex environments.
- With common user terminal architectures: stationary, desktop, wired belt-pack, wireless belt-pack and PC application.
- The wired user terminals support USB and Bluetooth headsets from the most basic, to the highest quality and best features.
- Rack and desktop equipment will use 4-way levers instead of keys, for easier operation of basic functions: Listen, Talk, and adjust the receive volume.
- Additional equipment is included to provide analog, digital and IP audio inputs and outputs to the system.
- The equipment has been designed to be very cost effective with optimum performance.
- Great audio quality (HD Voice up to 7 KHz) with bit rate limited to 64 kbps.

OPERATING MODES

Xpeak particular modes:

- **Virtual Matrix Mode:** The system without Matrix is configured directly from the Xpeak panels and belt-packs. It is compatible with the Xplorer Wireless Systems. The 8 Keys of the Stationary User panels and the 4 Keys of the Belt-packs are programmed with the same –flexibility as the AEQ-KROMA matrix systems. The maximum capacity of this Virtual matrix is for 28 user panels. Audio is HD 7KHz.

- **Party-line HD Mode:** The 4-channel Party-line mode is selected directly from the Xpeak user panels and belt-packs. This mode is also compatible with the Xplorer wireless system. Through four keys, it is selected which channels each Terminal speaks to and which channels each Terminal listens to. Audio is HD 7KHz.

Backward Compatibility Modes:

Crossnet and Conexia mode: See pages 14 and 15.

Easynet Mode: The new panels and belt-pack become user panels for the Party-line Easynet, compatible with the previous panels and with Xplorer. Audio is G711 Kroma legacy.

TECHNICAL FEATURES

Xpeak_R and Xpeak_D

- Ergonomics:
 - 8 x 4-way cross-point levers with associated RGB led.
 - 2 screens for menu and contextual information associated with the levers.
 - Rotary encoder, menu key and signalling LEDs.
 - Internal power supply.
 - Internal 1Gbps Ethernet switch, with two external RJ45 network ports to connect panels in “Daisy Chain” to a single switch port.
 - GPIO: 10-pin mini-Hartmann connector includes 2 opto-coupled GPIOs and 2 GPOs, one external circuit power pin, and ground.
 - Bluetooth: The equipment incorporates a Bluetooth connection as an audio interface with a telephone or headset.
- Front audio:
 - Gooseneck electret microphone supplied with the panel.
 - Internal speaker that develops 84 dB SPL @ 1 m.
- USB Audio:
 - Front USB for headsets.
 - Rear USB Type B: To incorporate PC audio.
- Bluetooth audio: The equipment can be paired with a Bluetooth device, for example a headset or a smartphone.
- It combines audio signals that arrive at the equipment from the different devices.
- Dimensions: Xpeak R: 482.6 x 44.5 mm. Depth 103 mm.
- Dimensions: Xpeak D: 217 x 105 mm. Depth 101 mm.
- Functional:
 - Talk, listen and volume on each lever for a crossover point.
 - Lever paging: 2 pages of levers, total 16 virtual levers.
 - Echo cancellation process.

Xpeak_BP

- Ergonomics:
 - 4 cross-point keys with associated RGB led.
 - Screen for menu and contextual information associated with the keys, with ON and OFF function.
 - Two rotary encoders for volume.
 - Two menu keys.
 - USB: 1 rear USB connector for headset.
 - Bluetooth for audio interface with a phone or headset.
 - Ethernet network connection. RJ45 connector with interlocking.
 - PoE power supply.
 - GPO: One GPO output through two pins.
 - Mechanics: Anti-shock plastic belt-pack.
- Dimensions: Front: Width: 92 mm. Depth: 70 mm. Height: 130 mm.
- Functional:
 - Keys pagination: 2 pages, total 8 virtual keys.
 - Echo cancellation.
 - Group LEDs: The LEDs that accompany each key have a programmable color to indicate the group to which each key belongs.
 - Front light signalling of incoming call.
 - The signalling of the key and communication status is carried out in the quadrant corresponding to each key in the idle screen of the display.

Xpeak_IF

- 4 Channel audio I/O converter for analog, USB and AoIP Dante / AES67 to 4 bidirectional G722 encoded channels that integrates with the virtual matrix or the party-line system.
- USB connection: The 4 USB audio ports are type B and allow you to connect audio from a PC.
- Ethernet connection: internal switch with two external network ports. Different uses: daisy chain, separation between Dante audio and encoded audio + Control.
- GPIO: Mini-Hartmann connectors include 4 opto-coupled GPIOs and 4 GPOs, external power pin and ground.
- 1.54" color TFT screen: allows information such as IP address, audio presence and status to be displayed.
- Encoder and menu key to navigate the user interface and facilitate configuration and status viewing.

Xplorer for Xpeak

- Ergonomics:
 - 4 cross-point keys with associated led.
 - Screen for menu and contextual information associated with the keys.
 - Two rotary encoders for volume and menu navigation.
 - Two menu keys.
 - Rear connector for specific headset.
 - Ethernet network connection via WiFi.
 - Power through rechargeable batteries. 20 hours of operation.
 - Recharge at the charging station.
 - Mechanics: Anti-shock plastic belt-pack.
- Dimensions: Front: Width: 92 mm. Depth: 70 mm. Height: 130 mm.
- Functional:
 - Internal programming of the Xpeak functionality.
 - On-screen display of Xpeak status and menus.
 - 2 pages of keys, total 8 virtual keys.
 - SDN support for virtual network.
 - Group LEDs: User group On-screen signalling.
 - Party Line operating mode with high quality audio G722.
 - Virtual Matrix operating mode with high quality audio G722.
 - Local reprogramming of keys in virtual matrix mode.

Xpeak Virtual

- Virtual user panel.
- PC software.
- Windows operating system.
- 8 virtual crossover keys.
- Compatible with Xpeak in all work modes.



Configuration software

Xpeak

“AEQ Xpeak” software is used for Xpeak control and configuration.



Xpeak user-panels features auto-discovery and auto-configuration functions. When a system is delivered it is preconfigured at factory. All of the system terminals will be ready to operate with basic functionality. Of course, adaption to each particular operational requirement will be needed and is easy to accomplish. A configuration software application has been developed for this purpose and with the following features:

- o Simple and visual software application.
- o Configuration through drag’n-drop actions.
- o Device auto-discovery.
- o Devices are organized in groups with common functionality, and in families sharing the same role, assigned by an administrator.

The software is organized through a window representing a workflow, with top and left menu areas. The rest of the screen, the main area, is divided in 4 quadrants, which sizes are adjusted according to needs:

- o Top Left: list of devices and groups.
- o Bottom Left: list of families.
- o Top Right: system diagram display area.
- o Bottom Right: selected device or group view.

MANAGING DEVICES

When the software is open, a list of the devices is presented. Each one has an associated icon and name. Names in white indicate devices operating and “on-line”. Names in red indicate devices that have been configured but are not currently available. Names and some properties can be edited, especially those associated to keys for communication with other devices. Equipment can also be manually added.

By clicking on a device –either on its name or on its representation in the diagram-, the bottom right area will show its detailed representation, providing access to each key so that it can be configured or modified.

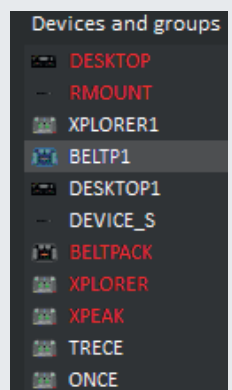



WORKING WITH KEYS

A communication function with other terminals can be programmed on each key, in order to hierarchize and sort communications so each user can talk to the required person and listen only to those messages affecting the user. Additionally, signalling and device remote control functions can also be programmed.

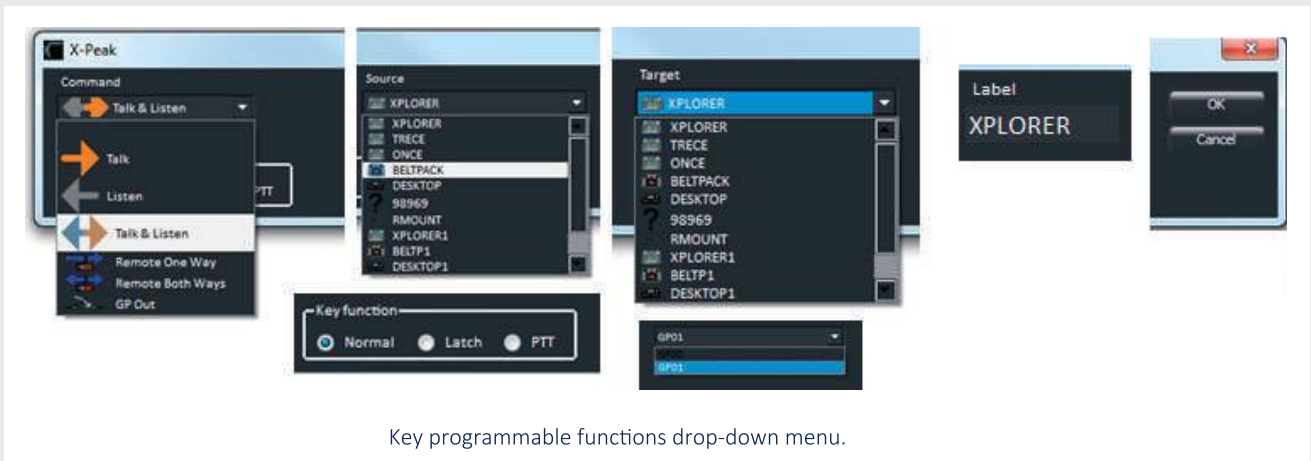

Key programmable functions drop-down menu.

XpeakD and Xpeak R panels feature levers where two key functions can be programmed: one key function is activated when the lever is pulled up, and the other one when pressed down. The rest of panels have simple keys, with a single programmable key function.

WORKING WITH GROUPS

Besides being created and deleted, group names can be edited and the devices that are part in each group can be selected.

WORKING WITH FAMILIES

Families can be created and deleted, but their names can also be changed, as well as the associated colour and the devices that are part of these families.

WORKING WITH DIAGRAMS

Physical location of each user terminal can be viewed on a blank window or over a drawing representing the work space, as well as the functional communications relationship between them: whom is able to talk to and listen to whom and doing what at any given moment.

In order to modify any relationship, place the cursor on the device that is originating the communication. It will be represented in the area located at the bottom right and it is possible to modify its keys, immediately representing the changes in the diagram above.

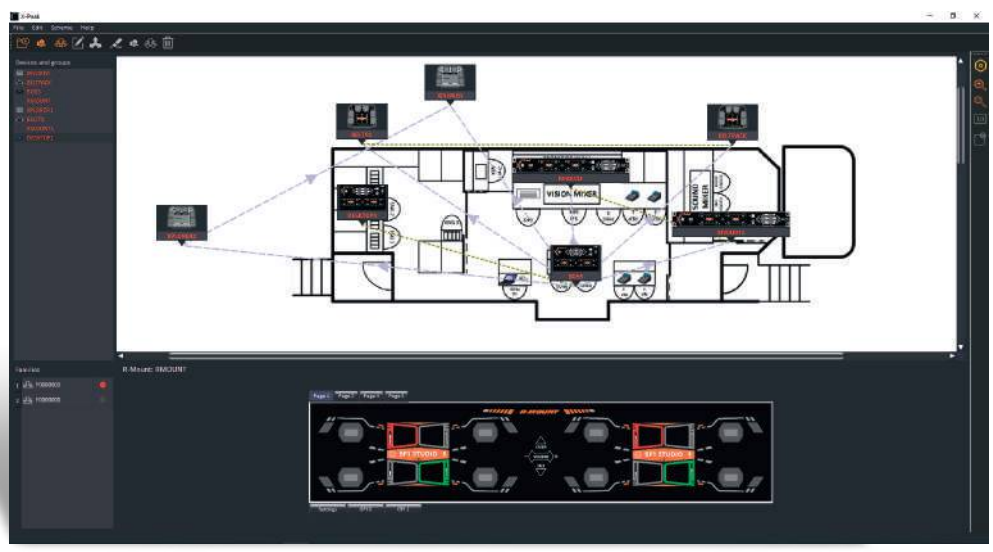

REMOTELY ASSUMING THE ROLE OF A DEVICE

A very special utility has been developed in order to test that a device operates as required: from the software, we can place the cursor on a device and work in parallel with it: use the keys depicted in the screen to talk to the destinations configured for it, and listen the messages reaching it from other panels through the PC we are running the software in.

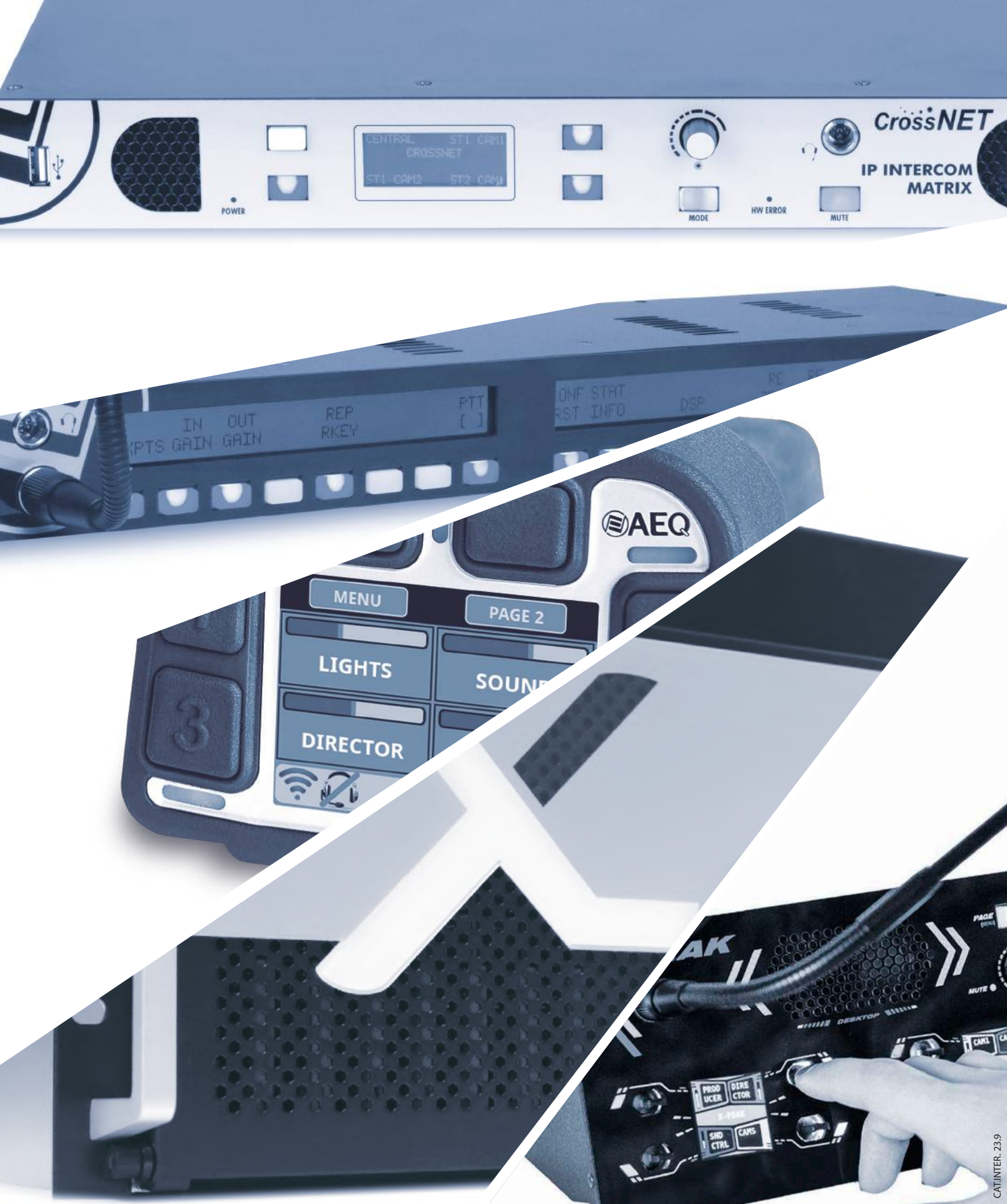

AEQ - HQ

Margarita Salas, 24
 28919 Leganés · Madrid · Spain
 Tel.: +34 91 686 13 00
 Fax: +34 91 686 44 92
 website: www.aeq.eu
 e-mail: aeqsales@aeq.es

AEQ - CATALUNYA

Tel.: +34 93 414 03 96
 e-mail: nolivella@aeq.es

AEQ - PORTUGAL

Tel.: +351 917 529 243
 e-mail: apicarra@aeq.es

AEQ - INDIA

Tel.: +91 98184 31432
 e-mail: tkurien@aeq.es

AEQ - KROMA MEXICO

Tel.: +55 54132716
 e-mail: creyna@aeq.es

AEQ - USA

Tel.: +1 (954) 581 79 99
 e-mail: sales@aeqbroadcast.com
 website: www.aeqbroadcast.com